INSTRUCTIONS

IMPORTANT SAFEGUARDS

When using electrical equipment, basic safety precautions should always be followed including the following:

1. **READ AND FOLLOW ALL SAFETY INSTRUCTIONS**
2. Disconnect power before performing work on electrical equipment.
3. Do not use outdoors.
4. Do not let power cords touch hot surfaces and do not mount near gas or electric heaters.
5. Use caution when servicing batteries. Battery acid can cause burns to skin and eyes. If acid is spilled on skin or eyes, flush with fresh water and contact a physician immediately.
6. Equipment should be mounted in locations and at heights where unauthorized personnel will not readily subject it to tampering.
7. The use of accessory equipment not recommended by the manufacturer, may cause an unsafe condition, and will void the unit's warranty.
8. Do not use this equipment for other than its intended purpose.
9. Servicing of this equipment should be performed by qualified service personnel.
10. **SAVE THESE INSTRUCTIONS!**

INSTALLATION

1. Extend unswitched 24 hour AC supply of rated voltage to a junction box or appropriate device wiring (supplied by others) installed in accordance with all applicable codes and standards. Leave at least 8 inches of slack wire. This circuit should NOT be energized/live at this time.
2. Drill 7/8" hole in area provided for AC supply and install bushing provided (Figure 2).
3. Mount the exit securely into place. Install four (4) mounting feet to the back of the cabinet. Fasten each foot with an appropriately sized screw or mounting bolt (not supplied) through each hole and into the mounting surface/wall. Each fastener must be securely in place to properly support the unit.
4. Open the unit by unscrewing the two (2) cover screws on the one side of the unit (Figure 2). The hinged door can then be swung down and the reflector inside lowered.
5. Chevrons are made of 2 layers of self-adhesive vinyl. Use a utility knife and dig under the outside corner of the chevron to be removed ensuring the utility knife has penetrated both layers of vinyl. Once the knife is under both layers of the chevron slowly begin to peel the chevron away from the lens following the contour of the chevron. If necessary repeat this process on the second chevron (Figure 4). Remove backing from double sided tape; align and stick coloured fibre/diffuser to inside of cover.
6. Make proper wiring connections between the AC supply and the sign (Figure 5). Insulate unused wire! Connect ground to supplied green ground wire in accordance with local codes. Reassemble all wire connections and connectors. CAUTION! - Failure to insulate unused wire may result in a shock hazard or unsafe condition as well as equipment failure. All wires must be dressed and routed to ensure they will not come in contact with the circuit board.
7. Position reflector and secure with ties.
8. Close cover and secure cover screws.
9. Turn on AC line voltage supply.

CAUTION

WARNING! Before servicing parts, ensure area is known to be non-hazardous

This equipment is furnished with a sophisticated low voltage battery dropout circuit to protect the battery from over-discharge after it's useful output has been used. Allow 24 hours recharge time after installation or power failure for full load testing.

Figure 1

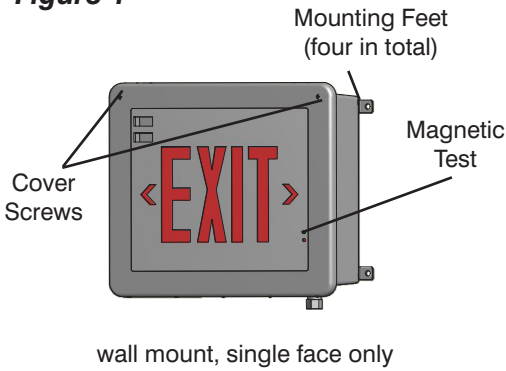

Figure 2

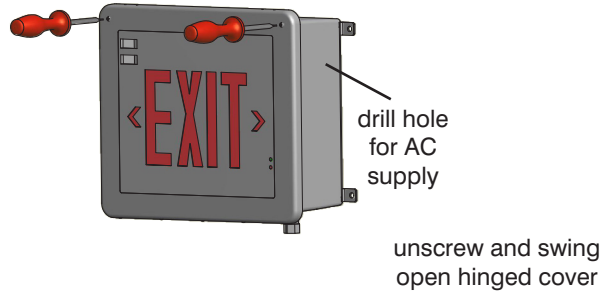

Figure 3

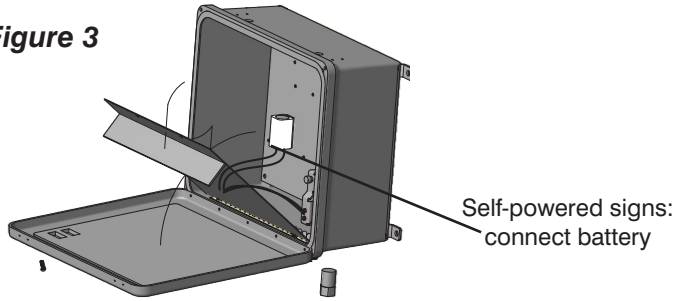

Figure 4

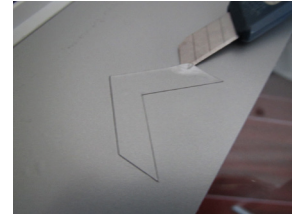
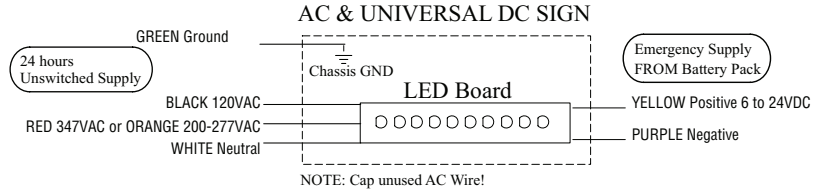
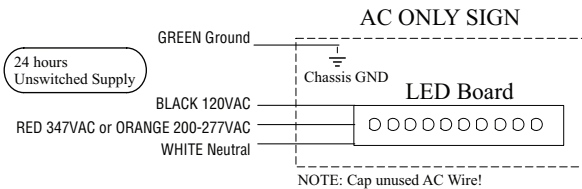
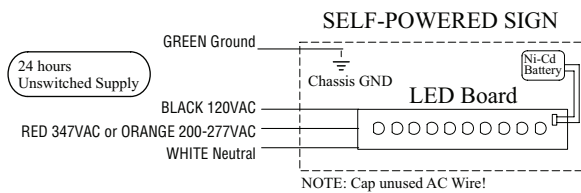
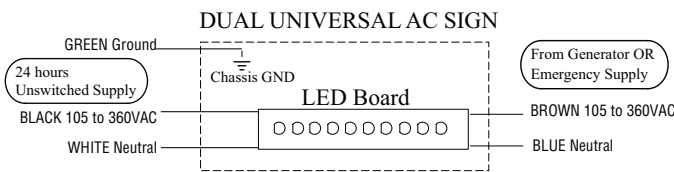

Figure 5



MAINTENANCE

1. The manufacturer strongly recommends compliance with all Code requirements.
2. The lamps listed herein when used according to the instructions with this unit are in accordance with the requirements of CSA Standard C22.2, No. 141 – Unit Equipment for Emergency Lighting.
3. Clean faceplates/lenses on a regular basis.

CAUTION: Always turn off AC power before servicing. The servicing of any parts, should be performed by qualified service personnel. The use of replacement parts not furnished by the manufacturer may cause equipment failure and will void the warranty.

TROUBLESHOOTING

EXIT SIGN DOES NOT COME ON AT ALL

1. Check AC supply and all AC connections - be sure exit has 24 hour AC supply (unswitched).
2. Check supply voltage and AC connections. The AC supply must be at least 80% of nominal (96V on a 120V line) for equipment to function normally. At lower voltages the LEDs may begin to glow dimly until the source voltage drops below the full “turn-on/off” point.
NOTE: This condition may also be caused by incorrectly connecting a voltage supply line to the transformer lead.
3. If AC supply is OK; replace LED circuit board assembly.

SAVE THESE INSTRUCTIONS